

# NTMD3N08LR2

## Power MOSFET 2.3 Amps, 80 Volts

### N-Channel Enhancement-Mode SO-8 Dual Package

#### Features

- Ultra Low On-Resistance Provides Higher Efficiency
  - ♦  $R_{DS(on)} = 0.215 \Omega$ ,  $V_{GS} = 10 \text{ V}$
  - ♦  $R_{DS(on)} = 0.245 \Omega$ ,  $V_{GS} = 5.0 \text{ V}$
- Low Reverse Recovery Losses
- Internal  $R_G = 50 \Omega$
- *Designed for Power Management Solutions in 42 V Automotive System Applications*
- $I_{DSS}$  and  $R_{DS(on)}$  Specified at Elevated Temperature
- Avalanche Energy Specified
- Miniature SO-8 Surface Mount Package - Saves Board Space
- Mounting Information for SO-8 Package Provided
- Pb-Free Package is Available

#### Applications

- Integrated Starter Alternator
- Electronic Power Steering
- Electronic Fuel Injection
- Catalytic Converter Heaters

#### MAXIMUM RATINGS ( $T_J = 25^\circ\text{C}$ unless otherwise noted)

Rating	Symbol	Value	Unit
Drain-to-Source Voltage	$V_{DSS}$	80	V
Drain-to-Source Voltage ( $R_{GS} = 1.0 \text{ m}\Omega$ )	$V_{DGR}$	80	
Gate-to-Source Voltage - Continuous	$V_{GS}$	$\pm 15$	V
Gate-to-Source Voltage - Non-Repetitive ( $t_p \leq 10 \text{ ms}$ )	$V_{GSM}$	$\pm 20$	
Continuous Drain Current @ $T_A = 25^\circ\text{C}$	$I_D$	2.3	A
Pulsed Drain Current (Note 1)	$I_{DM}$	25	
Total Power Dissipation @ $T_A = 25^\circ\text{C}$ (Note 2)	$P_D$	3.1	W
Operating and Storage Temperature Range	$T_J, T_{stg}$	-55 to +175	$^\circ\text{C}$
Single Pulse Drain-to-Source Avalanche Energy - Starting $T_J = 25^\circ\text{C}$ ( $V_{DD} = 50 \text{ Vdc}$ , $V_{GS} = 5.0 \text{ Vdc}$ , Peak $I_L = 7.0 \text{ Apk}$ , $L = 1.0 \text{ mH}$ , $R_G = 25 \Omega$ )	$E_{AS}$	25	mJ
Thermal Resistance - Junction-to-Ambient (Note 2)	$R_{\theta JA}$	48	$^\circ\text{C/W}$
Maximum Lead Temperature for Soldering Purposes for 10 Seconds	$T_L$	260	$^\circ\text{C}$

Stresses exceeding Maximum Ratings may damage the device. Maximum Ratings are stress ratings only. Functional operation above the Recommended Operating Conditions is not implied. Extended exposure to stresses above the Recommended Operating Conditions may affect device reliability.

1. Pulse Test: Pulse Width =  $10 \mu\text{s}$ , Duty Cycle = 2%
2. Mounted onto a 2" square FR-4 board (1in sq, oz. Cu 0.06" thick single sided),  $t \leq 5$  seconds



ON Semiconductor®

<http://onsemi.com>

**2.3 AMPERES  
80 VOLTS  
215 m $\Omega$  @  $V_{GS} = 5 \text{ V}$  (Typ)**

#### MARKING DIAGRAM & PIN ASSIGNMENT



SOIC-8  
CASE 751  
STYLE 11

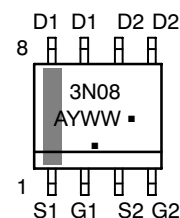

3N08 = Device Code  
A = Assembly Location  
Y = Year  
WW = Work Week  
▪ = Pb-Free Package

(Note: Microdot may be in either location)

#### ORDERING INFORMATION

Device	Package	Shipping†
NTMD3N08LR2	SO-8	2500/Tape & Reel
NTMD3N08LR2G	SO-8 (Pb-Free)	2500/Tape & Reel

†For information on tape and reel specifications, including part orientation and tape sizes, please refer to our Tape and Reel Packaging Specification Brochure, BRD8011/D.

# NTMD3N08LR2

## ELECTRICAL CHARACTERISTICS (T<sub>C</sub> = 25°C unless otherwise noted)

Characteristic	Symbol	Min	Typ	Max	Unit
----------------	--------	-----	-----	-----	------

### OFF CHARACTERISTICS

Drain-to-Source Breakdown Voltage (V <sub>GS</sub> = 0 Vdc, I <sub>D</sub> = 250 μAdc) Positive Temperature Coefficient	V <sub>(BR)DSS</sub>	80 -	- 99.8	- -	Vdc mV/°C
Zero Gate Voltage Drain Current (V <sub>DS</sub> = 80 Vdc, V <sub>GS</sub> = 0 Vdc) (V <sub>DS</sub> = 80 Vdc, V <sub>GS</sub> = 0 Vdc, T <sub>J</sub> = 150°C)	I <sub>DSS</sub>	- -	- -	2.0 250	μAdc
Gate-Body Leakage Current (V <sub>GS</sub> = 15 Vdc, V <sub>DS</sub> = 0 Vdc) (V <sub>GS</sub> = -15 Vdc, V <sub>DS</sub> = 0 Vdc)	I <sub>GSS</sub>	- -	- -	100 -100	nAdc

### ON CHARACTERISTICS

Gate Threshold Voltage (V <sub>DS</sub> = V <sub>GS</sub> , I <sub>D</sub> = 250 μAdc) Negative Temperature Coefficient	V <sub>GS(th)</sub>	1.0 -	1.9 4.6	3.0 -	Vdc mV/°C
Static Drain-to-Source On-State Resistance (V <sub>GS</sub> = 5.0 Vdc, I <sub>D</sub> = 1.0 Adc) (V <sub>GS</sub> = 10 Vdc, I <sub>D</sub> = 2.5 Adc) (V <sub>GS</sub> = 4.5 Vdc, I <sub>D</sub> = 1.0 Adc, T <sub>J</sub> @ 150°C)	R <sub>DS(on)</sub>	- - -	0.215 0.190 0.446	0.245 0.215 0.505	Ω

### DYNAMIC CHARACTERISTICS

Input Capacitance (V <sub>DS</sub> = 25 Vdc, V <sub>GS</sub> = 0 Vdc, f = 1.0 MHz)	C <sub>iss</sub>	-	218	480	pF
Output Capacitance (V <sub>DS</sub> = 25 Vdc, V <sub>GS</sub> = 0 Vdc, f = 1.0 MHz)	C <sub>oss</sub>	-	54	150	
Reverse Transfer Capacitance (V <sub>DS</sub> = 25 Vdc, V <sub>GS</sub> = 0 Vdc, f = 1.0 MHz)	C <sub>rss</sub>	-	15	50	

### SWITCHING CHARACTERISTICS (Notes 3 and 4)

Turn-On Delay Time (V <sub>DD</sub> = 40 Vdc, I <sub>D</sub> = 1.0 A, V <sub>GS</sub> = 4.5 V, R <sub>G</sub> = 27 Ω) (V <sub>DD</sub> = 40 Vdc, I <sub>D</sub> = 2.5 A, V <sub>GS</sub> = 10 V, R <sub>G</sub> = 47 Ω)	t <sub>d(on)</sub>	- -	21 13	34 -	ns
Rise Time (V <sub>DD</sub> = 40 Vdc, I <sub>D</sub> = 1.0 A, V <sub>GS</sub> = 4.5 V, R <sub>G</sub> = 27 Ω) (V <sub>DD</sub> = 40 Vdc, I <sub>D</sub> = 2.5 A, V <sub>GS</sub> = 10 V, R <sub>G</sub> = 47 Ω)	t <sub>r</sub>	- -	62 95	104 -	
Turn-Off Delay Time (V <sub>DD</sub> = 40 Vdc, I <sub>D</sub> = 1.0 A, V <sub>GS</sub> = 4.5 V, R <sub>G</sub> = 27 Ω) (V <sub>DD</sub> = 40 Vdc, I <sub>D</sub> = 2.5 A, V <sub>GS</sub> = 10 V, R <sub>G</sub> = 47 Ω)	t <sub>d(off)</sub>	- -	52 47	85 -	
Fall Time (V <sub>DD</sub> = 40 Vdc, I <sub>D</sub> = 1.0 A, V <sub>GS</sub> = 4.5 V, R <sub>G</sub> = 27 Ω) (V <sub>DD</sub> = 40 Vdc, I <sub>D</sub> = 2.5 A, V <sub>GS</sub> = 10 V, R <sub>G</sub> = 47 Ω)	t <sub>f</sub>	- -	48 104	81 -	
Total Gate Charge (V <sub>DS</sub> = 40 Vdc, V <sub>GS</sub> = 5.0 Vdc, I <sub>D</sub> = 1.0 A) (V <sub>DS</sub> = 40 Vdc, V <sub>GS</sub> = 10 Vdc, I <sub>D</sub> = 1.0 A)	Q <sub>G(TOT)</sub>	- -	5.1 8.8	9.0 15	nC
Gate-Source Charge (V <sub>DS</sub> = 40 Vdc, V <sub>GS</sub> = 5.0 Vdc, I <sub>D</sub> = 1.0 A)	Q <sub>GS</sub>	-	0.95	-	
Gate-Drain Charge (V <sub>DS</sub> = 40 Vdc, V <sub>GS</sub> = 5.0 Vdc, I <sub>D</sub> = 1.0 A)	Q <sub>GD</sub>	-	2.75	-	
Threshold Gate Charge (V <sub>DS</sub> = 40 Vdc, V <sub>GS</sub> = 5.0 Vdc, I <sub>D</sub> = 1.0 A)	Q <sub>G(TH)</sub>	-	0.35	-	

### BODY-DRAIN DIODE RATINGS (Note 3)

Diode Forward On-Voltage (I <sub>S</sub> = 1.0 Adc, V <sub>GS</sub> = 0 V) (I <sub>S</sub> = 1.0 Adc, V <sub>GS</sub> = 0 V, T <sub>J</sub> = 150°C)	V <sub>SD</sub>	- -	0.8 0.6	1.0 -	Vdc
Reverse Recovery Time (I <sub>S</sub> = 1.0 A, dI <sub>S</sub> /dt = 100 A/μs, V <sub>GS</sub> = 0 V)	t <sub>rr</sub>	-	47	93	ns
	t <sub>a</sub>	-	25	-	
	t <sub>b</sub>	-	22	-	
Reverse Recovery Stored Charge (I <sub>S</sub> = 1.0 A, dI <sub>S</sub> /dt = 100 A/μs, V <sub>GS</sub> = 0 V)	Q <sub>RR</sub>	-	0.067	0.134	μC

- Indicates Pulse Test: Pulse Width = 300 μs max, Duty Cycle = 2%.
- Switching characteristics are independent of operating junction temperatures.

TYPICAL ELECTRICAL CHARACTERISTICS

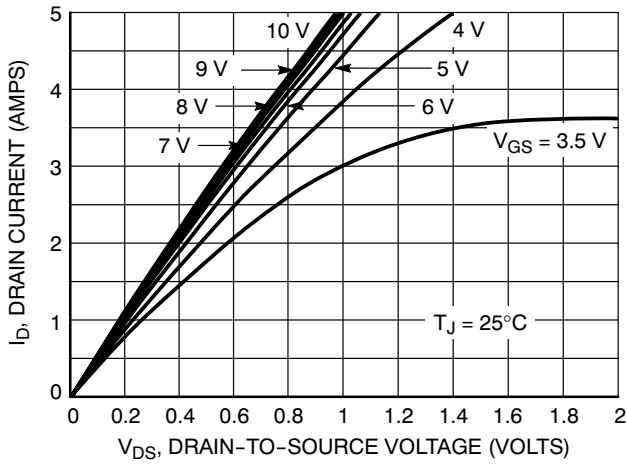

Figure 1. On-Region Characteristics

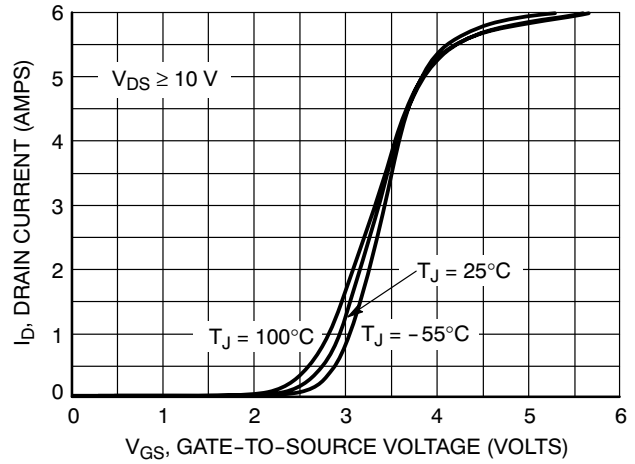

Figure 2. Transfer Characteristics

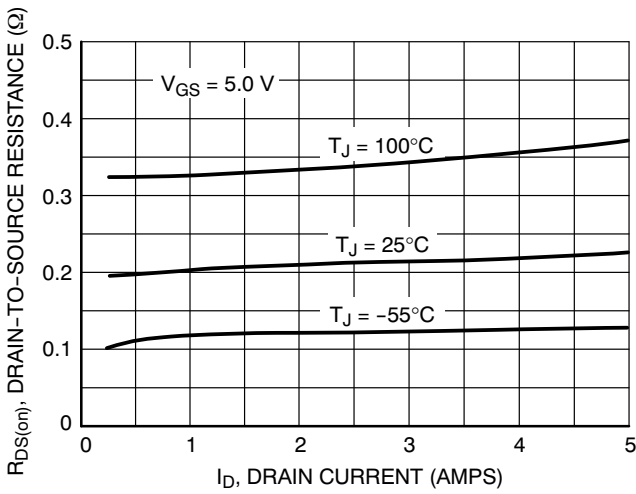

Figure 3. On-Resistance versus Drain Current and Temperature

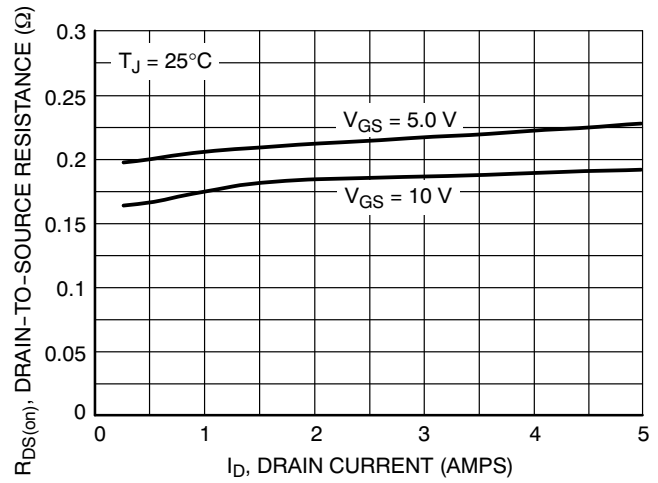

Figure 4. On-Resistance versus Drain Current and Gate Voltage

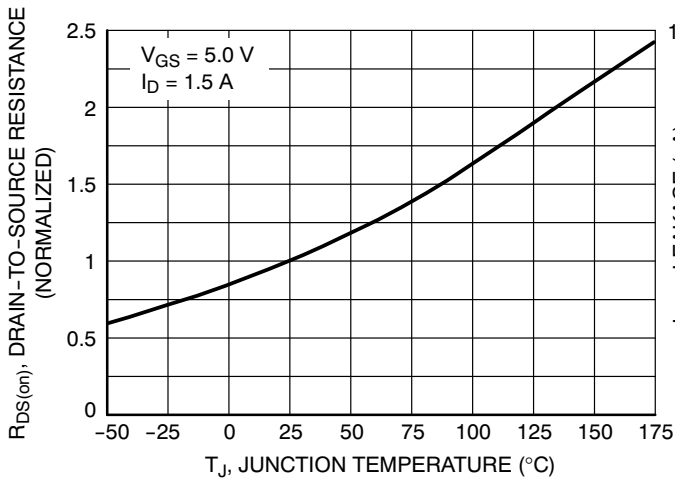

Figure 5. On-Resistance Variation with Temperature

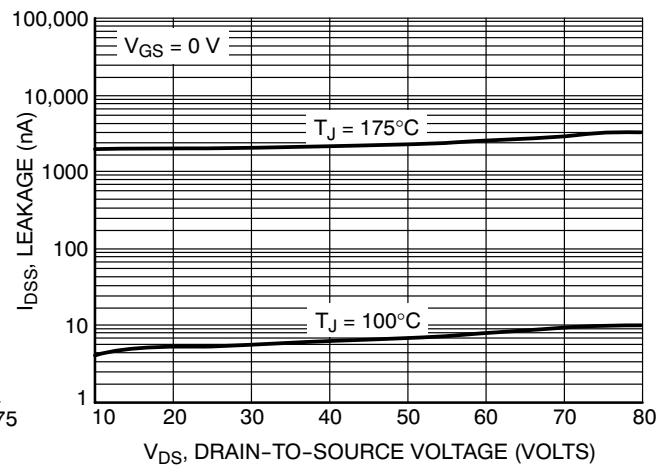

Figure 6. Drain-To-Source Leakage Current versus Voltage

POWER MOSFET SWITCHING

Switching behavior is most easily modeled and predicted by recognizing that the power MOSFET is charge controlled. The lengths of various switching intervals ( $\Delta t$ ) are determined by how fast the FET input capacitance can be charged by current from the generator.

The published capacitance data is difficult to use for calculating rise and fall because drain-gate capacitance varies greatly with applied voltage. Accordingly, gate charge data is used. In most cases, a satisfactory estimate of average input current ( $I_{G(AV)}$ ) can be made from a rudimentary analysis of the drive circuit so that

$$t = Q/I_{G(AV)}$$

During the rise and fall time interval when switching a resistive load,  $V_{GS}$  remains virtually constant at a level known as the plateau voltage,  $V_{GSP}$ . Therefore, rise and fall times may be approximated by the following:

$$t_r = Q_2 \times R_G / (V_{GG} - V_{GSP})$$

$$t_f = Q_2 \times R_G / V_{GSP}$$

where

$V_{GG}$  = the gate drive voltage, which varies from zero to  $V_{GG}$

$R_G$  = the gate drive resistance

and  $Q_2$  and  $V_{GSP}$  are read from the gate charge curve.

During the turn-on and turn-off delay times, gate current is not constant. The simplest calculation uses appropriate values from the capacitance curves in a standard equation for voltage change in an RC network. The equations are:

$$t_{d(on)} = R_G C_{iss} \ln [V_{GG}/(V_{GG} - V_{GSP})]$$

$$t_{d(off)} = R_G C_{iss} \ln (V_{GG}/V_{GSP})$$

The capacitance ( $C_{iss}$ ) is read from the capacitance curve at a voltage corresponding to the off-state condition when calculating  $t_{d(on)}$  and is read at a voltage corresponding to the on-state when calculating  $t_{d(off)}$ .

At high switching speeds, parasitic circuit elements complicate the analysis. The inductance of the MOSFET source lead, inside the package and in the circuit wiring which is common to both the drain and gate current paths, produces a voltage at the source which reduces the gate drive current. The voltage is determined by  $L di/dt$ , but since  $di/dt$  is a function of drain current, the mathematical solution is complex. The MOSFET output capacitance also complicates the mathematics. And finally, MOSFETs have finite internal gate resistance which effectively adds to the resistance of the driving source, but the internal resistance is difficult to measure and, consequently, is not specified.

The resistive switching time variation versus gate resistance (Figure 9) shows how typical switching performance is affected by the parasitic circuit elements. If the parasitics were not present, the slope of the curves would maintain a value of unity regardless of the switching speed. The circuit used to obtain the data is constructed to minimize common inductance in the drain and gate circuit loops and is believed readily achievable with board mounted components. Most power electronic loads are inductive; the data in the figure is taken with a resistive load, which approximates an optimally snubbed inductive load. Power MOSFETs may be safely operated into an inductive load; however, snubbing reduces switching losses.

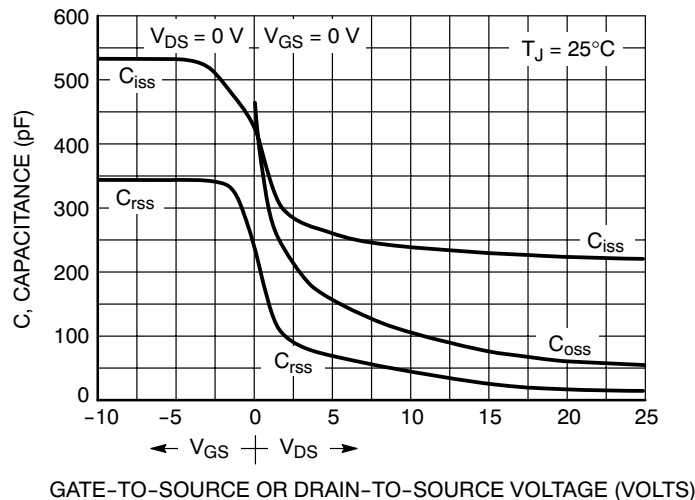
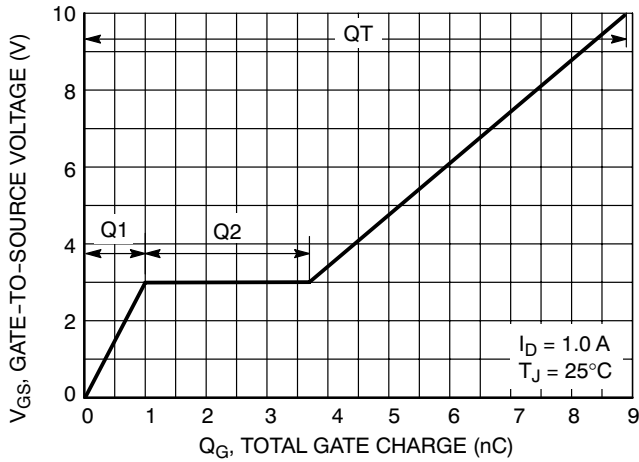
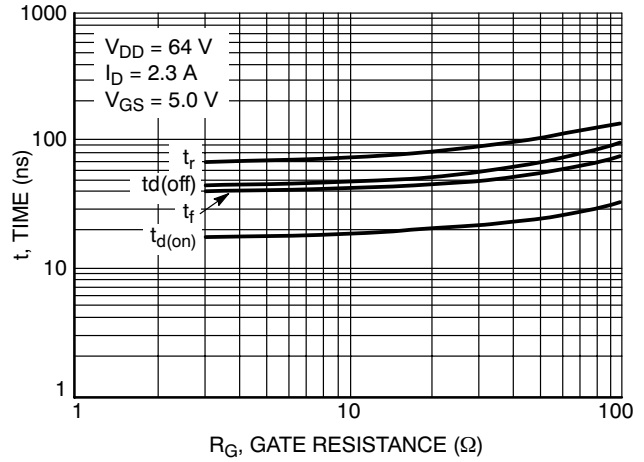

Figure 7. Capacitance Variation

# NTMD3N08LR2



**Figure 8. Gate-To-Source and Drain-To-Source Voltage versus Total Charge**



**Figure 9. Resistive Switching Time Variation versus Gate Resistance**

## DRAIN-TO-SOURCE DIODE CHARACTERISTICS

The switching characteristics of a MOSFET body diode are very important in systems using it as a freewheeling or commutating diode. Of particular interest are the reverse recovery characteristics which play a major role in determining switching losses, radiated noise, EMI and RFI.

System switching losses are largely due to the nature of the body diode itself. The body diode is a minority carrier device, therefore it has a finite reverse recovery time,  $t_{rr}$ , due to the storage of minority carrier charge,  $Q_{RR}$ , as shown in the typical reverse recovery wave form of Figure 14. It is this stored charge that, when cleared from the diode, passes through a potential and defines an energy loss. Obviously, repeatedly forcing the diode through reverse recovery further increases switching losses. Therefore, one would like a diode with short  $t_{rr}$  and low  $Q_{RR}$  specifications to minimize these losses.

The abruptness of diode reverse recovery effects the amount of radiated noise, voltage spikes, and current ringing. The mechanisms at work are finite irremovable circuit parasitic inductances and capacitances acted upon by

high  $di/dt$ s. The diode's negative  $di/dt$  during  $t_a$  is directly controlled by the device clearing the stored charge. However, the positive  $di/dt$  during  $t_b$  is an uncontrollable diode characteristic and is usually the culprit that induces current ringing. Therefore, when comparing diodes, the ratio of  $t_b/t_a$  serves as a good indicator of recovery abruptness and thus gives a comparative estimate of probable noise generated. A ratio of 1 is considered ideal and values less than 0.5 are considered snappy.

Compared to ON Semiconductor standard cell density low voltage MOSFETs, high cell density MOSFET diodes are faster (shorter  $t_{rr}$ ), have less stored charge and a softer reverse recovery characteristic. The softness advantage of the high cell density diode means they can be forced through reverse recovery at a higher  $di/dt$  than a standard cell MOSFET diode without increasing the current ringing or the noise generated. In addition, power dissipation incurred from switching the diode will be less due to the shorter recovery time and lower switching losses.

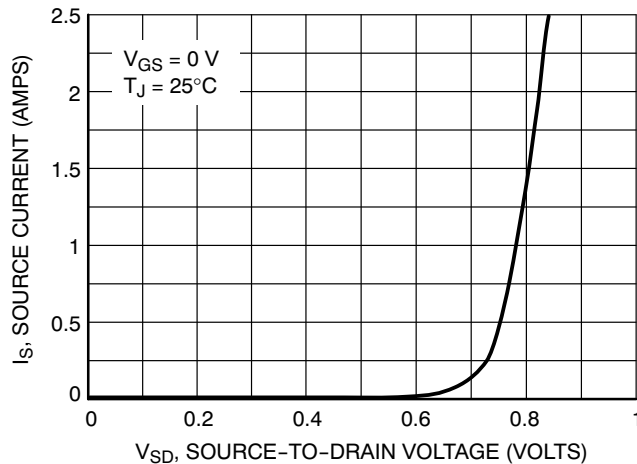

**Figure 10. Diode Forward Voltage versus Current**

SAFE OPERATING AREA

The Forward Biased Safe Operating Area curves define the maximum simultaneous drain-to-source voltage and drain current that a transistor can handle safely when it is forward biased. Curves are based upon maximum peak junction temperature and a case temperature ( $T_C$ ) of 25°C. Peak repetitive pulsed power limits are determined by using the thermal response data in conjunction with the procedures discussed in AN569, "Transient Thermal Resistance - General Data and Its Use."

Switching between the off-state and the on-state may traverse any load line provided neither rated peak current ( $I_{DM}$ ) nor rated voltage ( $V_{DSS}$ ) is exceeded, and that the transition time ( $t_r, t_f$ ) does not exceed 10  $\mu$ s. In addition the

total power averaged over a complete switching cycle must not exceed  $(T_{J(MAX)} - T_C)/(R_{\theta JC})$ .

A power MOSFET designated E-FET can be safely used in switching circuits with unclamped inductive loads. For reliable operation, the stored energy from circuit inductance dissipated in the transistor while in avalanche must be less than the rated limit and must be adjusted for operating conditions differing from those specified. Although industry practice is to rate in terms of energy, avalanche energy capability is not a constant. The energy rating decreases non-linearly with an increase of peak current in avalanche and peak junction temperature.

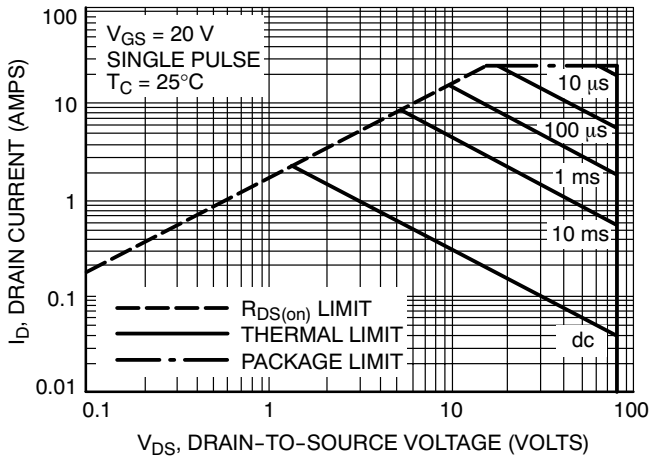

Figure 11. Maximum Rated Forward Biased Safe Operating Area

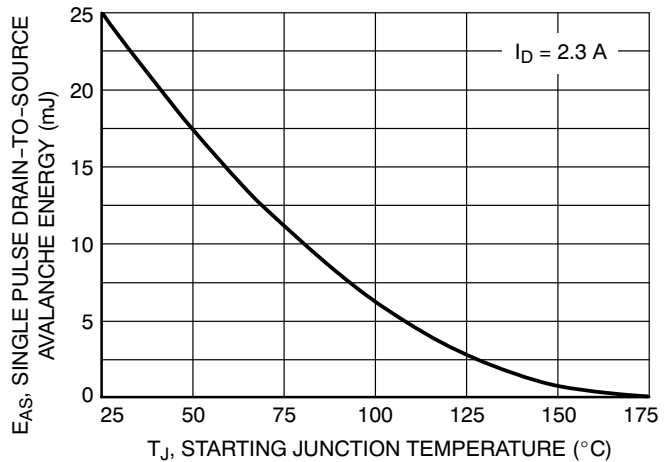

Figure 12. Maximum Avalanche Energy versus Starting Junction Temperature

# NTMD3N08LR2

## TYPICAL ELECTRICAL CHARACTERISTICS

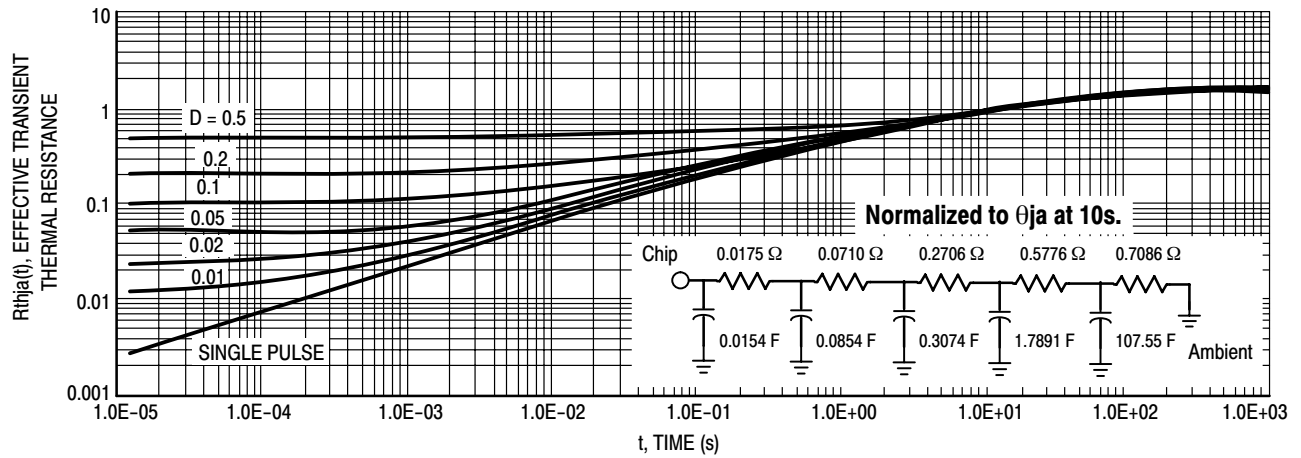

Figure 13. Thermal Response

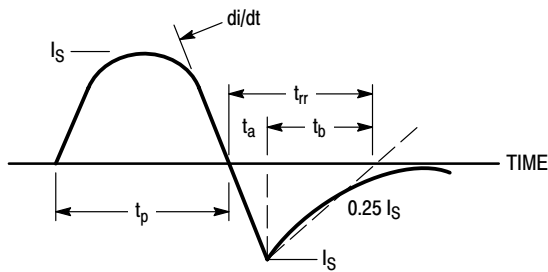
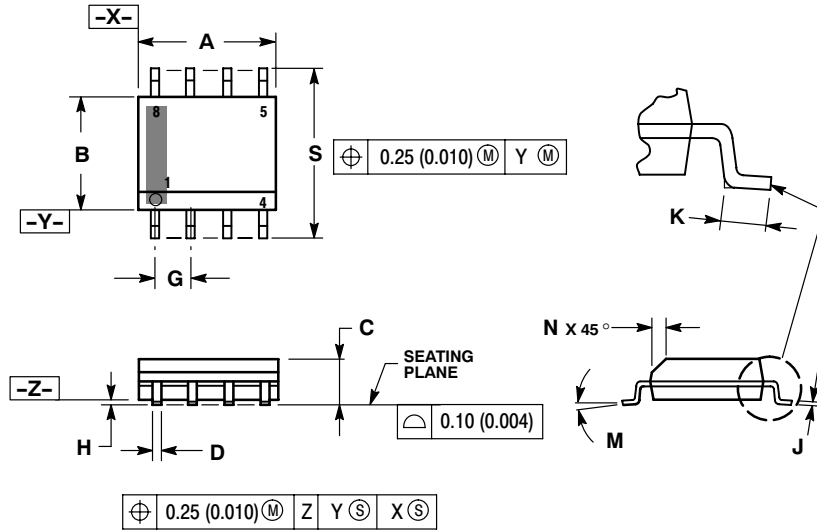

Figure 14. Diode Reverse Recovery Waveform

# NTMD3N08LR2

## PACKAGE DIMENSIONS

SO-8  
CASE 751-07  
ISSUE AG



NOTES:

1. DIMENSIONING AND TOLERANCING PER ANSI Y14.5M, 1982.
2. CONTROLLING DIMENSION: MILLIMETER.
3. DIMENSION A AND B DO NOT INCLUDE MOLD PROTRUSION.
4. MAXIMUM MOLD PROTRUSION 0.15 (0.006) PER SIDE.
5. DIMENSION D DOES NOT INCLUDE DAMBAR PROTRUSION. ALLOWABLE DAMBAR PROTRUSION SHALL BE 0.127 (0.005) TOTAL IN EXCESS OF THE D DIMENSION AT MAXIMUM MATERIAL CONDITION.
6. 751-01 THRU 751-06 ARE OBSOLETE. NEW STANDARD IS 751-07.

DIM	MILLIMETERS		INCHES	
	MIN	MAX	MIN	MAX
A	4.80	5.00	0.189	0.197
B	3.80	4.00	0.150	0.157
C	1.35	1.75	0.053	0.069
D	0.33	0.51	0.013	0.020
G	1.27 BSC		0.050 BSC	
H	0.10	0.25	0.004	0.010
J	0.19	0.25	0.007	0.010
K	0.40	1.27	0.016	0.050
M	0°	8°	0°	8°
N	0.25	0.50	0.010	0.020
S	5.80	6.20	0.228	0.244

STYLE 11:

- PIN 1. SOURCE 1
- GATE 1
- SOURCE 2
- GATE 2
- DRAIN 2
- DRAIN 2
- DRAIN 1
- DRAIN 1

### SOLDERING FOOTPRINT\*

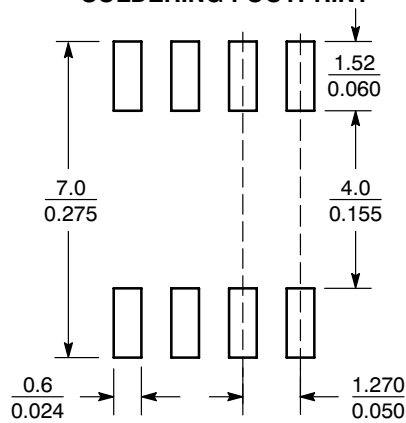

SCALE 6:1 (mm/inches)

\*For additional information on our Pb-Free strategy and soldering details, please download the ON Semiconductor Soldering and Mounting Techniques Reference Manual, SOLDERRM/D.

ON Semiconductor and are registered trademarks of Semiconductor Components Industries, LLC (SCILLC). SCILLC reserves the right to make changes without further notice to any products herein. SCILLC makes no warranty, representation or guarantee regarding the suitability of its products for any particular purpose, nor does SCILLC assume any liability arising out of the application or use of any product or circuit, and specifically disclaims any and all liability, including without limitation special, consequential or incidental damages. "Typical" parameters which may be provided in SCILLC data sheets and/or specifications can and do vary in different applications and actual performance may vary over time. All operating parameters, including "Typicals" must be validated for each customer application by customer's technical experts. SCILLC does not convey any license under its patent rights nor the rights of others. SCILLC products are not designed, intended, or authorized for use as components in systems intended for surgical implant into the body, or other applications intended to support or sustain life, or for any other application in which the failure of the SCILLC product could create a situation where personal injury or death may occur. Should Buyer purchase or use SCILLC products for any such unintended or unauthorized application, Buyer shall indemnify and hold SCILLC and its officers, employees, subsidiaries, affiliates, and distributors harmless against all claims, costs, damages, and expenses, and reasonable attorney fees arising out of, directly or indirectly, any claim of personal injury or death associated with such unintended or unauthorized use, even if such claim alleges that SCILLC was negligent regarding the design or manufacture of the part. SCILLC is an Equal Opportunity/Affirmative Action Employer. This literature is subject to all applicable copyright laws and is not for resale in any manner.

### PUBLICATION ORDERING INFORMATION

LITERATURE FULFILLMENT:

Literature Distribution Center for ON Semiconductor  
P.O. Box 61312, Phoenix, Arizona 85082-1312 USA  
Phone: 480-829-7710 or 800-344-3860 Toll Free USA/Canada  
Fax: 480-829-7709 or 800-344-3867 Toll Free USA/Canada  
Email: orderlit@onsemi.com

N. American Technical Support: 800-282-9855 Toll Free  
USA/Canada

Japan: ON Semiconductor, Japan Customer Focus Center  
2-9-1 Kamimeguro, Meguro-ku, Tokyo, Japan 153-0051  
Phone: 81-3-5773-3850

ON Semiconductor Website: <http://onsemi.com>

Order Literature: <http://www.onsemi.com/litorder>

For additional information, please contact your local Sales Representative.